

Outback

2016

Quick Reference Guide



Love. It's what makes a Subaru, a Subaru.



Complete U.S. specifications and illustrations may not have been available at time of publication. Specifications are based on the latest product information available at time of publication. Some images shown are for illustration purposes only. Some equipment shown may be optional at extra cost. Specific options may be available only in combination with other options. Specific combinations of equipment or features may vary from time to time and by geographic area. Certain accessories and equipment may not be available at the time of publication.

This Quick Reference Guide applies to all Outback models. Therefore, some explanations may be for equipment not installed on your vehicle. Subaru of America, Inc., reserves the right to change or discontinue at any time, without notice, prices, colors, materials, equipment, accessories, specifications, models and packages without incurring any obligation to make the same or similar changes on vehicles previously sold. Colors shown may vary due to reproduction process.

For detailed operating and safety information, please consult the Owner's Manual.

Subaru, Outback, Legacy, Forester, Impreza, BRZ, WRX, WRX STI, BOXER, Lineartronic, EyeSight, HD Radio, Aha Radio and SiriusXM are registered trademarks. SUBARU STARLINK is a trademark of Fuji Heavy Industries, Ltd.

All rights reserved. Contents may not be reprinted or electronically reproduced in whole or in part without prior written approval of Subaru of America, Inc.

© 2015 Subaru of America, Inc.

Table of Contents

2–5	Getting Started
6–7	Instrument Panel
8–11	Gauges
12–13	Personalize
14–21	Controls
22–27	While Operating
28–29	Safety/In Case of Emergency
30–31	Additional Information

Remote Keyless Entry

1. Lock/Arm

- Press to lock all doors and the rear gate and activate the security alarm.
- If any of the doors or the rear gate are not fully closed, an electronic chirp will sound and the hazard lights will flash to alert you that the doors or the rear gate are not properly closed.
- To activate the vehicle finder function, press three times (within five seconds). If you are within 30 feet of the vehicle, the horn will sound one time and the hazard lights will flash three times.

2. Unlock/Disarm

- Press once to unlock the driver's door.
- Press twice (within five seconds) to unlock all doors.
- When the "Unlock/Disarm" button is pressed, the dome and map lights will illuminate if the dome light switch is in the middle position.

3. Unlocking the Rear Gate

- Press the button to unlock the rear gate.

4. Panic Alarm

- Press once and the horn will sound and the hazard lights will flash.
- Press any button on the remote to deactivate.



Keyless Access and Push Button Start (if equipped)

By simply carrying the access key in your pocket, you can lock and unlock doors, open the rear gate and start your car without having to take the key fob out of your pocket.

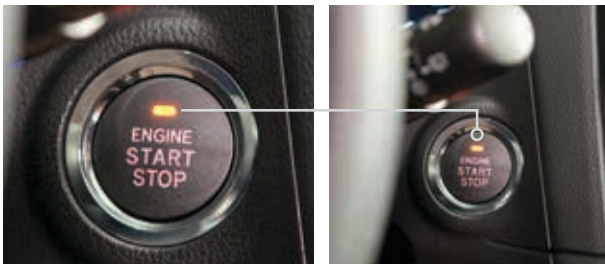

Seating

Heated Front Seats (if equipped)

Press the front seat heater switch. Each time you press the switch, the mode will change as follows: High, Mid, Low, Off.



10-Way Power Driver's Seat (if equipped)

1. Forward/Backward, Angle and Height

Move the switch toward the front or rear to move the seat forward or backward. Pull the switch up or push down on the front of the switch to adjust the angle of the seat cushion. Pulling the switch straight up or pushing the switch straight down will adjust the height of the entire seat cushion.

2. Seatback

Move the switch in the corresponding direction to adjust the angle of the seatback.

3. Lumbar Support

Press the front part of the switch to increase lumbar support; press the rear part of the switch to decrease lumbar support.

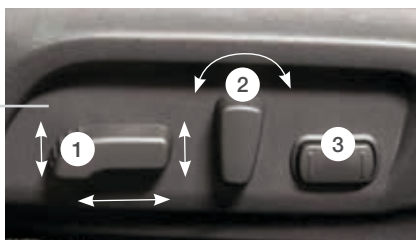

Rear Seat Heater (if equipped)

Press the rear seat heater switch. Each time you press the switch, the mode will change as follows: High, Low, Off.



Instrument Panel

Gauges

Personalize

Controls

While Operating

Safety/In Case of Emergency

Additional Information

Seating

Seat Controls

1. Forward/Backward

Pull up on the lever below the front of the driver's seat to move the seat forward or backward.

2. Raise/Lower Seat Cushion

To adjust the height of the driver's seat, pull up or push down the seat height adjustment lever, located on the lower left front of the seat.

3. Recline Seatback

To adjust the seatback to the desired position, pull up on the recline lever, located on the lower left rear of the driver's seat or lower right rear of the passenger's seat. Do not adjust seats while driving.

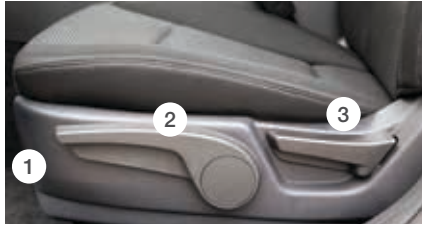

Folding the Rear Seat

From Inside the Vehicle

Push the release button on the top of the seatback that you want to fold down. To return the seatback to its original position, raise the seatback until it locks into place, making sure that it is securely locked.



From the Rear of the Vehicle

Pull the release lever on the seat side that you want to fold down. To return the seatback to its original position, raise the seatback until it locks into place, making sure that it is securely locked.



Instrument Panel

Gauges

Personalize

Controls

While Operating

Safety/In Case of Emergency

Additional Information

Instrument Panel

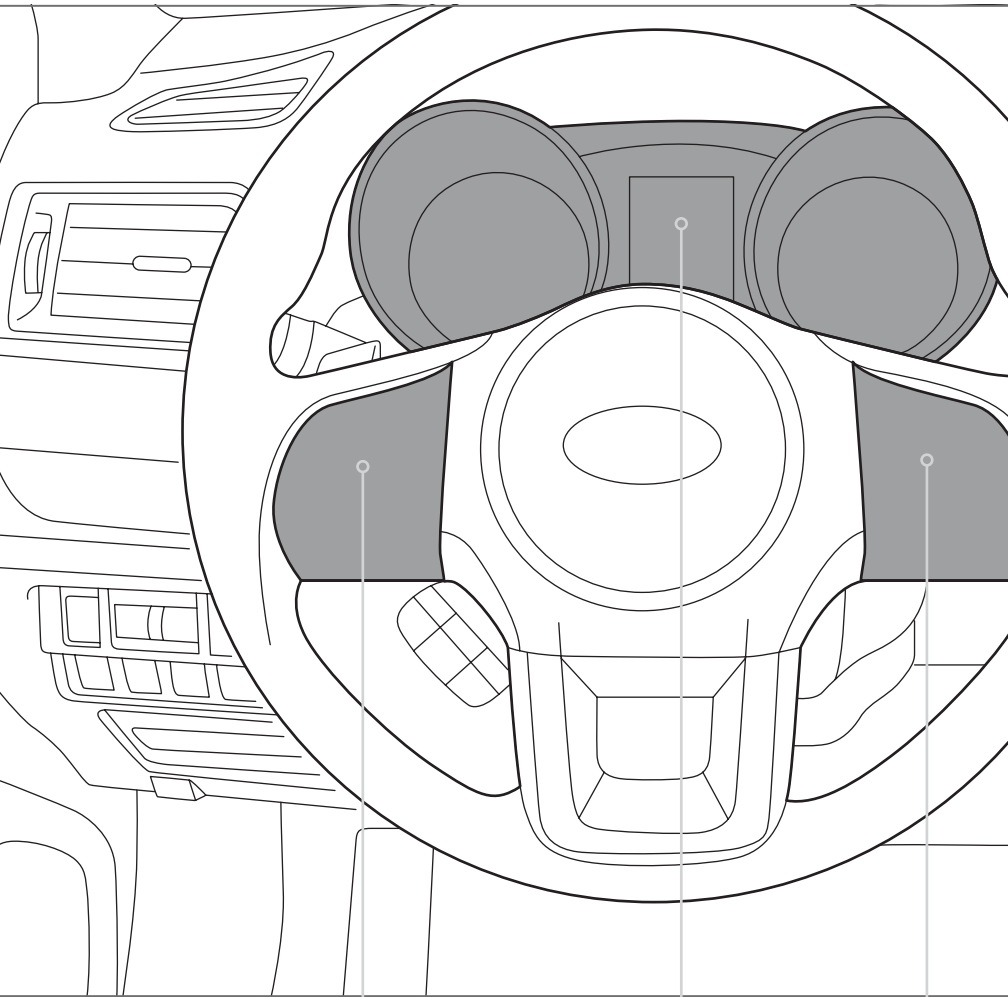

PAGE NUMBER	20	8-11	21
----------------	----	------	----

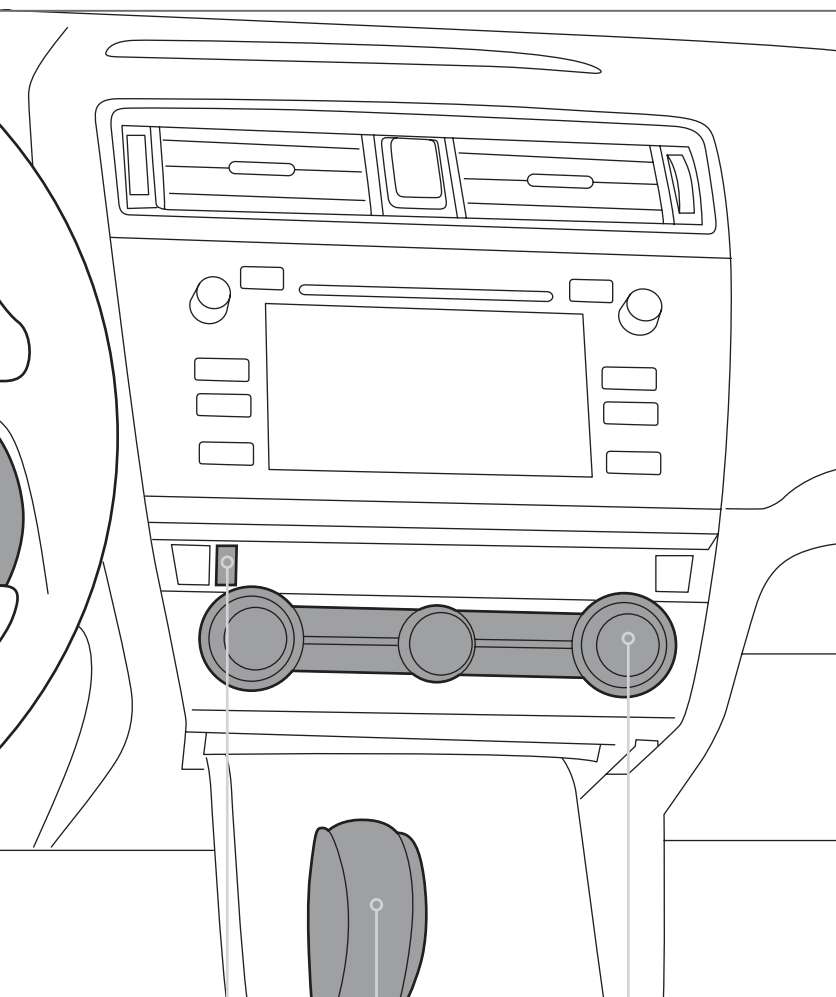

23

16-17

Clock

Press the “+” button to advance the time or the “-” button to reverse the time. Vehicles with a navigation system, please refer to the separate “Operating Instructions for Navigation System.”

Gauges

Outback 2.5i

- Immediate Attention
- Caution
- ■ Informational



Trip meter reset button

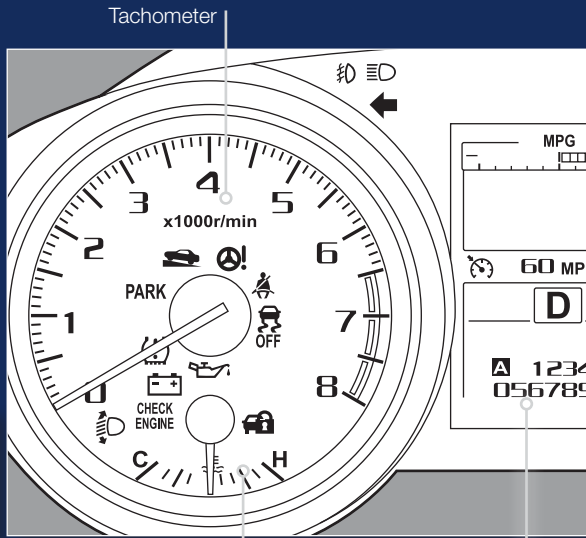

Temperature gauge

Trip meter and odometer



Seatbelt warning



Hot coolant temperature/
Cold coolant temperature



Front passenger
seatbelt warning



High beam indicator light



SRS airbag system



Engine oil level warning



Security indicator light



AT OIL TEMP
(Automatic Transmission)



Charge warning



ABS warning



Oil pressure warning



Low fuel

BRAKE / (P) Brake system



All-Wheel Drive
(Automatic Transmission)

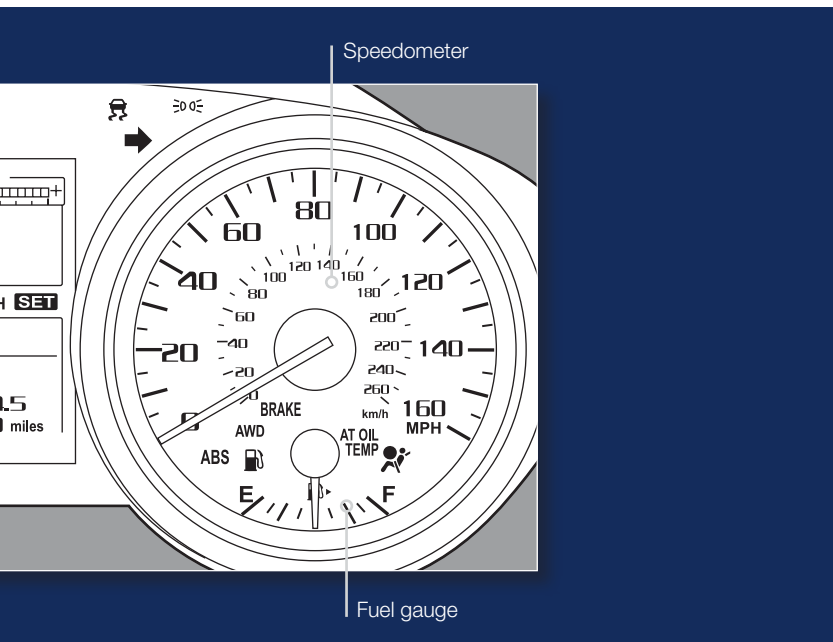

Vehicle Dynamics Control/Vehicle Dynamics Control operation



Hill Holder



Vehicle Dynamics Control OFF



Turn signals



CHECK ENGINE/
Malfunction indicator



Front fog light indicator light (if equipped)



Tire pressure warning light



Headlight indicator light



Front passenger frontal airbag ON



Front passenger frontal airbag OFF



Low windshield washer fluid

Gauges

Outback 2.5i Premium
 Outback 2.5i Limited
 Outback 3.6R Limited

- Immediate Attention
- Caution
- ■ Informational



Trip meter reset button

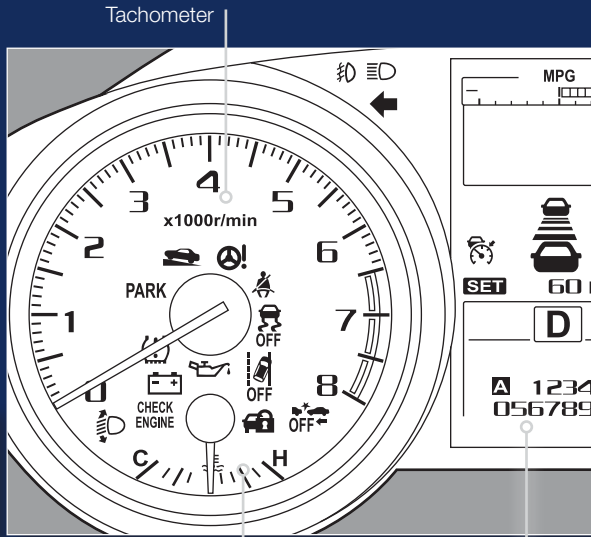

Temperature gauge

Trip meter and odometer



Seatbelt warning



Door open (if equipped)



Front passenger seatbelt warning



Hot coolant temperature/
Cold coolant temperature



SRS airbag system



High beam indicator light



Security indicator light



Engine oil level warning



Charge warning



AT OIL TEMP
(Automatic Transmission)



Oil pressure warning



ABS warning

BRAKE / Brake system



Low fuel

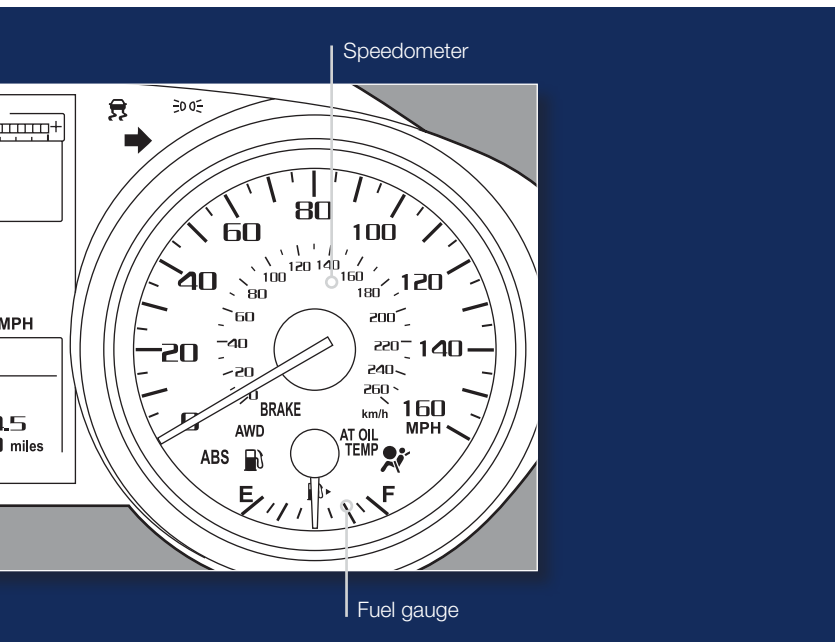

AWD

All-Wheel Drive (Automatic Transmission)



Low windshield washer fluid



Vehicle Dynamics Control/Vehicle Dynamics Control operation



Hill Holder



Vehicle Dynamics Control OFF



Turn signals

CHECK ENGINE

CHECK ENGINE/ Malfunction indicator



Front fog light indicator light (if equipped)



Tire pressure warning light



Headlight indicator light

ON /

Front passenger frontal airbag ON

OFF /

Front passenger frontal airbag OFF

Personalize

Tilt and Telescopic Steering Column

Push the lever down firmly to adjust the height and lengthwise position of the column; firmly push the lever back up to lock the column in place. Do not adjust while driving.



Power Exterior Mirrors

Turn the knob to the “L” side to adjust the left-hand mirror or to the “R” side to adjust the right-hand mirror. Move the knob in the direction you want to move the mirror. Then return the knob to the neutral/center position.



Controls

Light Controls

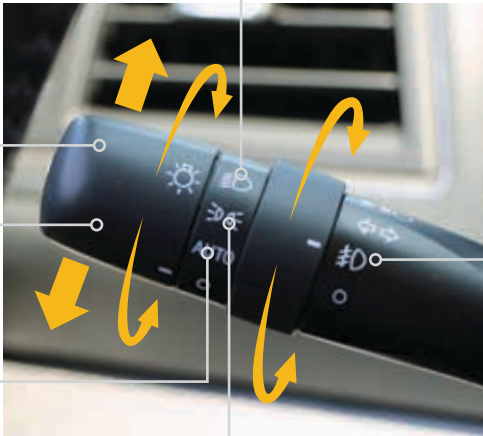

Turns on headlights, instrument panel illumination, parking lights, tail lights and license plate lights.

Push up for right turn signal.

Push down for left turn signal.

Turns on fog lights (if equipped).

AUTO: The vehicle's lights are automatically on or off, depending on the level of outside light.

Turns on instrument panel lights, tail lights, parking lights and license plate lights.

While the light switch is on, rotate the dial downward to dim the instrument panel illumination. Rotate the dial upward to make the illumination brighter. When the dial is fully rotated upward, the instrument panel illumination becomes full bright.







Windshield Wipers

To turn on the wipers, press the wiper control lever down one level for intermittent, two levels for low, or three levels for high speed. Return the lever to the “OFF” position to stop the wipers. For a single wipe, move the lever up. To spray washer fluid, pull and hold the lever toward you.

To operate the rear wiper, rotate the end of the knob upward to the intermittent, continuous, or wash position. When the rear wiper is off, rotate the knob downward to wash and wipe the rear window.

Daytime Running Lights

Daytime running lights are standard on your vehicle. Only a reduced brightness high beam will be automatically turned on when the engine has started, the parking brake is fully released and the light switch is in the “OFF” or “” position. The brightness of the illumination of the high beam headlights is reduced by the daytime running light system. You must always switch on your headlights when it is dark outside by turning the light switch to the “” position.

Controls



Manual Climate Control (if equipped)

1. Fan Speed Control Dial

Rotate the fan speed control dial to select one of four fan speeds.

2. Air Conditioning Button

Press the "A/C" button to activate the air conditioning. Press it again to turn off the air conditioning.

3. Air Flow Mode Selection Button

Press the "MODE" button to select the desired air flow mode. The selected air flow mode – either ventilation, bi-level, heat or heat-defrost – is shown on the display.

4. Recirculated/Outside Air Button

Press the air inlet selection button to prevent outside air from being drawn into the passenger compartment. If the button is pushed in, press it again to draw outside air into the compartment.
TO PREVENT WINDSHIELD FOGGING,
DO NOT REMAIN IN THE RECIRCULATED
MODE FOR AN EXTENDED PERIOD
OF TIME.

5. Temperature Control Dial

Rotate the temperature control dial from blue for cool, to red for warm. Rotate the dial all the way left for MAX A/C.

6. Defrost/Defog

To clear the windshield and front door windows of fog or frost, press the defrost button, set the temperature control to the red position, and set the fan speed control to the fastest speed.

While in defrost mode, the air inlet selection and A/C will operate automatically (although the A/C indicator will illuminate if the button was depressed prior to or during defrost mode).

7. Rear Window Defogger Button

Press the rear window defogger button to turn on the defogger. The defogger will automatically shut off after about 15 minutes. If the window clears before that time, you can press the button again to turn it off.



Dual Zone Automatic Climate Control System (if equipped)

1. Automatic On and Off

This system automatically controls outlet air temperature, fan speed, air flow distribution, air inlet control, and air conditioner compressor operation. Press “AUTO” to activate. Press “OFF” to turn off the system.

2. Temperature Control Dial

Rotate the dial clockwise to increase the temperature or rotate the dial counterclockwise to decrease the temperature. The temperature is displayed digitally on the screen.

Separate temperature settings can be adjusted for the driver’s side and passenger’s side.

Operation in Manual Mode

3. Air Conditioner Button

Press the “A/C” button to activate the air conditioning. Press it again to turn off the air conditioning.

4. Air Flow Mode Selection Buttons

Press the buttons to select the desired air flow mode. The selected air flow mode – either ventilation, bi-level, heat, heat-defrost or defrost – is shown on the display.

5. Fan Speed Control Buttons

Press the fan speed control buttons to select the desired fan speed.

6. Recirculated/Outside Air Button

Press the air inlet selection button to prevent outside air from being drawn into the passenger compartment. Press the button again to allow outside air into the compartment. **TO PREVENT WINDSHIELD FOGGING, DO NOT REMAIN IN THE RECIRCULATED MODE FOR AN EXTENDED PERIOD OF TIME.**

7. Dual Mode Button

Press the “DUAL” button to activate or deactivate the dual mode. Dual mode makes it possible to have separate temperature settings for the driver’s side and passenger’s side.

8. Defroster Button

Press the button to defrost or dehumidify the windshield and front door windows.

9. Rear Window Defogger Button

Press the button to turn on the defogger. It will automatically shut off after about 15 minutes. If the window clears before that time, you can press the button again to turn it off.

Controls

Power Moonroof (if equipped)

With the moonroof in the fully closed position, press the switch ② to tilt the rear of the moonroof up. Press and hold the switch ① to lower the moonroof. Press the switch ④ to fully open the moonroof. Press the switch ③ to close the moonroof. To stop the moonroof in a midway position while opening or closing, momentarily press the switch to the ④ side or ③ side.



Vehicles equipped with EyeSight and/or STARLINK Safety and Security System.





Auxiliary Input Jack

The 3.5 mm auxiliary input jack is located in the front of the center console. You can connect a portable music player to the auxiliary jack and hear the music stored on it through the vehicle speakers. Press the "SOURCE" button located on the audio system to select the auxiliary mode.

USB Port

The USB port is located in the front of the center console. You can connect a USB-equipped portable music player to the USB port and hear the music stored on it through the vehicle speakers. Press the "SOURCE" button located on the audio system repeatedly until the USB mode is selected.

Controls

Steering Wheel Audio Controls (if equipped)

Push the top (+) of the switch to increase or the bottom (-) of the switch to decrease volume.

Press to turn audio ON/OFF or to select the cursor entry.

With any of the radio modes selected, push the switch left or right to skip through your presets. In CD mode, push the switch up or down to skip forward or back a track.





Press the button to show the list screen.

Press the button to return to the previous screen.

Press the button to select the desired audio mode – FM, AM, SAT, CD, AUX, MEDIA.

Talk switch; please refer to the “Bluetooth audio” section in your Owner’s Manual.

Cruise Control

To activate the cruise control, press the “” button. The indicator light on the instrument panel will turn on. To deactivate cruise control, press the “” button again.

To resume your speed after canceling, push the switch to the “RES” side.



To cancel the cruise control, push the brake pedal or press the “CANCEL” button. If you have a manual transmission, you can push in the clutch pedal.

Press the accelerator pedal until your vehicle reaches the desired speed. Push the switch to the “SET” side and release. Ease off the accelerator pedal. Your vehicle will maintain the desired speed.

Increase speed

Push up the “RES/SET” switch to the “RES” side; hold until your vehicle reaches the desired speed and release. To increase speed using the accelerator pedal, press the pedal until you reach the desired speed. Push down the “RES/SET” switch to the “SET” side to set the speed.

Decrease speed

Push down the “RES/SET” switch to the “SET” side; hold until your vehicle slows to the desired speed and release. To decrease the speed using the brake pedal, press the pedal to release cruise control temporarily. When the speed decreases to the desired speed, push down the “RES/SET” switch to the “SET” side to set the speed.

While Operating

Electronic Parking Brake

To apply, push the brake pedal and pull up the parking brake switch. The brake system warning light on the instrument panel and the indicator light on the parking brake switch will illuminate.

To release, make sure all doors are closed and your seatbelt is fastened, then gently push the accelerator pedal. Or, while the ignition switch is in the ON position and the brake pedal is pushed in, push down the parking brake switch.



Hill Holder™ Function

To activate, press the Hill Holder switch. To deactivate, press the Hill Holder switch again. When the Hill Holder function is activated, the parking brake will be automatically applied when stopped on an uphill or downhill slope with the brake pedal pushed down. The brake system warning light on the instrument panel and the indicator light on the parking brake switch will illuminate.

Paddle Shift Control Switches (if equipped)

- Temporary use: Even when the selector is in the “D” (Drive) position, you can temporarily shift the gear by pulling the “+” or “-” paddle shift control switch. The transmission will automatically switch back to Normal Mode.
- When the selector lever is in Manual Mode, shift to the next higher gear by pulling the “+” paddle shift control switch on the steering wheel. Pull the “-” paddle shift control switch to shift into the next lower gear.





Automatic Transmission Shift Mode

The Continuously Variable Transmission (CVT) gives you ultimate control with two different driving modes: Normal Mode and Manual Mode.

Normal Mode

When the selector lever is in the “D” (Drive) position, the transmission is in Normal shift mode. The shift position indicator on the instrument panel shows “D” and the transmission automatically shifts into a suitable forward gear.

Manual Mode

In Manual Mode, you select the desired gear position to obtain necessary acceleration and engine braking. Moving the selector lever left into the manual gate ① from the “D” (Drive) position causes the transmission to change into Manual Mode. To shift, use the paddle shift control switches. The shift position indicator shows the selected gear position.

When Manual Shifting Operation Is Possible

- Arrow-shaped lights in the center of the instrument panel show whether an upshift is possible and whether a downshift is possible.
- Both arrows are on: Upshifting and downshifting are both possible.
- Up arrow only is on: Only upshifting is possible.
- Down arrow only is on: Only downshifting is possible.

2.5i Engine Compartment

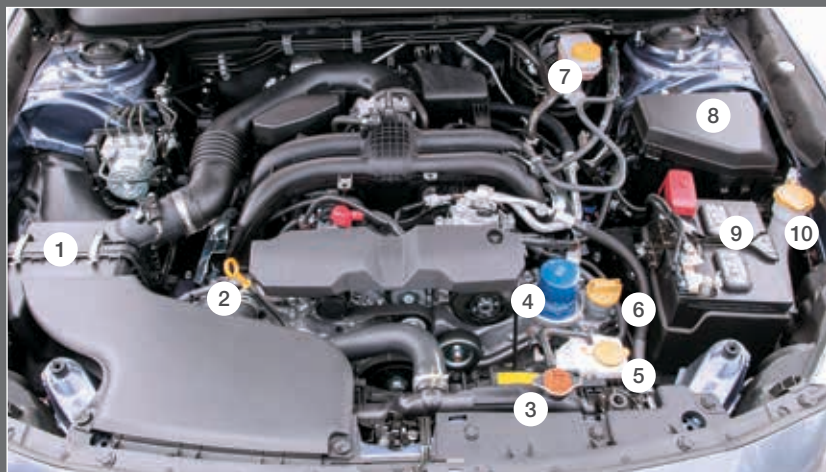

1. Air Cleaner Element

This element filters intake air. Follow the maintenance guidelines in your “Warranty and Maintenance Booklet.” When necessary, replace this element with a genuine Subaru air cleaner.

2. Engine Oil Level Gauge

Check the engine oil level at each fuel stop. Pull out the dipstick, wipe it clean, and insert it again. Pull it out and check the oil level. If it is below the lower level, add oil to bring the level up to the upper level. (Use only engine oil of the recommended grade and viscosity. Please refer to your Owner’s Manual for oil recommendations and other important details.)

3. Radiator Cap

If your engine overheats, safely pull off the road and stop your vehicle in a safe place. Never attempt to remove the radiator cap until the engine has

been shut off and has fully cooled down. If steam is coming from the engine compartment, turn the engine off and move everyone away from the vehicle until it cools. Please refer to your Owner’s Manual for details.

4. Engine Oil Filter

Change the oil filter according to the maintenance schedule in the “Warranty and Maintenance Booklet.”

5. Engine Coolant Reservoir

Check your coolant level at each fuel stop. Observe the coolant level on the outside of the reservoir while the engine is cool. If the level is close to – or lower than – the “LOW” level mark, add coolant to the “FULL” level mark. If the reserve tank is empty, remove the radiator cap and refill as required. Please refer to your Owner’s Manual for details.

6. Engine Oil Filler Cap

Change your oil according to the maintenance schedule in your “Warranty and Maintenance Booklet.” Your engine oil must be changed more frequently when you drive on dusty roads, frequently make short trips, or when you drive in extremely cold weather.

7. Brake Fluid Reservoir

Check your brake fluid level monthly. Observe the fluid level on the outside of the reservoir. If the level is below the “MIN” level mark, add the recommended brake fluid (FMVSS No. 116, fresh DOT 3 or 4 brake fluid) to the “MAX” level mark. Use only brake fluid from a sealed container.

8. Main Fuse Box

Your Outback has two fuse boxes. One is located under the instrument panel, behind the fuse box cover on the driver's seat side. The other is housed in your engine compartment, as shown here. Fuses are designed to melt during an overload situation in order to prevent damage to the wiring harness and electrical equipment. If any lights, accessories or electrical controls fail to operate properly, inspect the corresponding fuse. If it has blown, replace it in accordance with the instructions in your Owner's Manual. The fuse puller and spare fuses are located in the main fuse box in the engine compartment.

9. Battery

When your vehicle does not start due to a battery that has run down, the vehicle may be jump-started by connecting your battery to another battery with jumper cables.

Jump-starting is dangerous if done incorrectly. Please refer to your Owner's Manual for instructions. If you are unsure about how to jump-start your vehicle, please consult a competent mechanic.

10. Windshield Washer Tank

It is a good idea to check your washer fluid every time you stop for fuel. If the level is low, fill the windshield washer tank to the neck of the reservoir with windshield washer fluid. In cold weather, use a freeze-resistant windshield washer fluid.

3.6R Engine Compartment



1. Air Cleaner Element

This element filters intake air. Follow the maintenance guidelines in your “Warranty and Maintenance” booklet. When necessary, replace this element with a genuine Subaru air cleaner.

2. Radiator Cap

If your engine overheats, safely pull off the road and stop your vehicle in a safe place. Never attempt to remove the radiator cap until the engine has been shut off and has fully cooled down. If steam is coming from the engine compartment, turn the engine off and move everyone away from the vehicle until it cools. Please refer to your Owner’s Manual for details.

3. Engine Oil Level Gauge

Check the engine oil level at each fuel stop. Pull out the dipstick, wipe it clean, and insert it again. Pull it out and check the oil level. If it is below the lower level, add oil to bring the level up to the upper level. (Use only engine oil of the recommended grade and viscosity. Please refer to your Owner’s Manual for oil recommendations and other important details.)

4. Engine Coolant Reservoir

Check your coolant level at each fuel stop. Observe the coolant level on the outside of the reservoir while the engine is cool. If the level is close to – or lower than – the “LOW” level mark, add coolant to the “FULL” level mark. If the reserve tank is empty, remove the radiator cap and refill as required. Please refer to your Owner’s Manual for details.

5. Engine Oil Filler Cap

Change your oil according to the maintenance schedule in your “Warranty and Maintenance Booklet.” Your engine oil must be changed more frequently when you drive on dusty roads, frequently make short trips, or when you drive in extremely cold weather.

6. Brake Fluid Reservoir

Check your brake fluid level monthly. Observe the fluid level on the outside of the reservoir. If the level is below the “MIN” level mark, add the recommended brake fluid (FMVSS No. 116, fresh DOT 3 or 4 brake fluid) to the “MAX” level mark. Use only brake fluid from a sealed container.

7. Main Fuse Box

Your Outback has two fuse boxes. One is located under the instrument panel, behind the fuse box cover on the driver’s seat side. The other is housed in your engine compartment, as shown here. Fuses are designed to melt during an overload situation in order to prevent damage to the wiring harness and electrical equipment. If any lights, accessories or electrical controls fail to operate properly, inspect the corresponding fuse. If it has blown, replace it in accordance with the instructions in your Owner’s Manual. The fuse puller and spare fuses are located in the main fuse box in the engine compartment.

8. Battery

When your vehicle does not start due to a battery that has run down, the vehicle may be jump-started by connecting your battery to another battery with jumper cables.

Jump-starting is dangerous if done incorrectly. Please refer to your Owner’s Manual for instructions. If you are unsure about how to jump-start your vehicle, please consult a competent mechanic.

9. Windshield Washer Tank

It is a good idea to check your washer fluid every time you stop for fuel. If the level is low, fill the windshield washer tank to the neck of the reservoir with windshield washer fluid. In cold weather, use a freeze-resistant windshield washer fluid.

Safety/In Case of Emergency

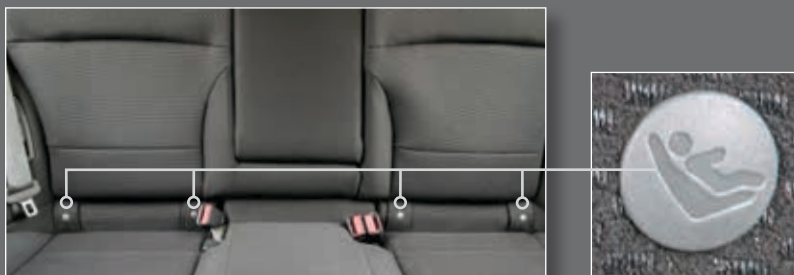

Child Restraint System

For maximum safety, first carefully read the LATCH system instructions from the device manufacturer, as well as the installation instructions in your Owner's Manual, to properly install the LATCH compatible restraint system. Use the appropriate seatbelts or anchorages provided in your vehicle. Children age 12 and under must properly occupy the rear seat at all times.

Child Safety Locks

The child safety locks are located on the inside edges of the rear doors. In the locked position, the rear doors can only be opened from the outside.





Location of Spare Tire and Jack

A jack and other maintenance tools are stored in the tool bucket in the center of the spare tire, located in the trunk or cargo area. Raise the center lid and remove the bucket from the center of the spare tire. Take the jack out of the bucket. The jack handle is stowed on the back of the center lid of the cargo area.

Emergency Towing Your All-Wheel Drive Vehicle

Since all-wheel drive distributes engine power to all four wheels, improper towing will severely damage your AWD system. A flatbed truck is the only recommended way to properly transport your AWD vehicle. If towing is necessary, it is best done by your Subaru retailer or a commercial towing service.

Subaru Roadside Assistance

Subaru Roadside Assistance is free and standard on every 2016 Subaru vehicle. Coverage is automatic; there are no forms to complete. Subaru Roadside Assistance is available anytime during the 3-year/36,000-mile Subaru Limited Warranty, whichever comes first.* A Subaru Roadside Assistance decal has been affixed to the driver's door window.

Subaru Roadside Assistance:
1-800-261-2155

Exclusions

Specifically excluded from Subaru Roadside Assistance coverage are service requests or claims resulting from: accidents, vandalism, acts of God, violation of any laws, misuse and abuse, or vehicle modifications not recommended by the manufacturer.

*See your retailer for details.

Additional Information

Fuel

For both the 2.5 liter 4-cyl. engine and the 3.6 liter 6-cyl. engine, use regular unleaded gasoline with an octane rating of 87 AKI or higher. Consult the Owner's Manual for more detailed information.

Fuel Capacity

- 18.5 US gal (70 liters, 15.4 Imp gal)
- When the low fuel indicator light is displayed on the instrument panel, approximately 2.6 US gal (10.0 liters, 2.2 Imp gal) of fuel remain.
- If you have recently fueled your vehicle, the check engine light on the instrument panel may stay on due to a missing or loose fuel filler cap (the cap should be tightened until a click is heard).

Engine Oil

Use only the following oils:

- API classification SM or SN with the words “ENERGY CONSERVING” or “RESOURCE CONSERVING.”
- Or ILSAC GF-4 or GF-5, which can be identified with the ILSAC certification mark (Starburst mark).
 - 2.5 liter 4-cyl. DOHC models use 0W-20 synthetic, replacement interval 6,000 miles under normal driving conditions. No requirement at the first 3,000 miles.
 - 3.6 liter 6-cyl. models use 5W-30, replacement interval 6,000 miles under normal driving conditions. No requirement at the first 3,000 miles.

Engine Oil Capacity

- 2.5 liter 4-cyl. models: 5.1 US qt (4.8 liters, 4.2 Imp qt)
- 3.6 liter 6-cyl. models: 6.9 US qt (6.5 liters, 5.7 Imp qt)

Vehicle Delivery Checklist

Delivery Information

V.I.N. _____

Delivery Date _____

Owner(s) _____

Phone # _____

Email _____

Registration & Appointment

MySubaru/SUBARU STARLINK™ Registration

Enrolled No Thanks

1st Service Appointment

Scheduled No Thanks

Manuals & Warranties

- Review vehicle manuals & maintenance schedule
- Review warranty information
(Basic, Powertrain, Tire, Wear Items & Adjustments)
- Review Subaru Roadside Assistance 1 (800) 261-2155

Retailer Orientation

- Parts & Service departments locations & hours
- Service Advisor introduction and/or business card
- Service appointment & "Early Bird"
drop-off procedures

Vehicle Condition

- Exterior/Interior is clean and undamaged
- Verify that all equipment, accessories and options
are present

Note any exceptions: _____

Steering Wheel & Instrument Panel

- Master and Valet Keys, Keyless Access System operation, Push Button Start* and Remote Start*
- Tilt/Telescopic Steering Column Adjustments and Paddle Shift operation*
- Front & Rear* Wiper and Washer Controls
- Headlights, DRL, Parking Lights, Hazard Lights, Interior Lights, and Fog Lights*
- Gauges, Warning Lights, Multi Function Display* settings and Parking Brake operation

STARLINK Audio System & Bluetooth

- Bluetooth - Pair owner's phone(s) & show operation (Download SUBARU STARLINK and MySubaru Apps*)
- STARLINK Audio* and Navigation* system controls (Sources, Presets, List & Back buttons)

Safety, Comfort & Convenience

- All Wheel Drive System, Emergency towing of AWD, VDC, X-Mode* and Hill Holder* operation
- Rear Vision Camera*
- All Weather Package operation - Heated Seats, Exterior Mirrors & Windshield Wiper De-icer
- Review operation of climate control system
- Power windows, locks, exterior mirrors, seat and Power Moonroof* operation
- Hood Release and fluid reservoir locations
- Fuel Filler Door, Trunk Release, Rear Gate operation and location of Spare Tire*, Jack & Tools

Driver Assist Technology

- Subaru EyeSight™ System* and SRF*
- Blind Spot Detection* and Rear Cross Traffic Alert*

*If Applicable

Owner Signature(s) _____

Subaru Sales Consultant _____

Subaru Sales Manager _____

Subaru of America, Inc., Subaru Plaza,
P.O. Box 6000, Cherry Hill, NJ 08034-6000



MSA5B1604A
Issued September 2015
Printed in USA 09/15

